

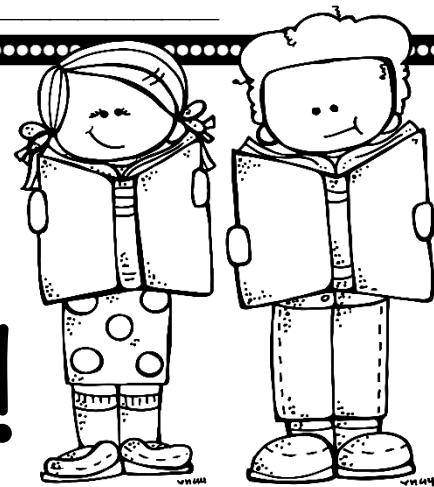

Name: _____ Due Date: _____

Create a Book Jacket!



It's your job to create a book jacket! This project will be creative and fun! The purpose of a book jacket is to entice the reader by showing them highlights of the book in words and pictures. Be careful not to give away the entire plot!

	REAR FLAP	BACK COVER	SPINE	FRONT COVER	FRONT FLAP
Designing Your Book Jacket	AUTHOR'S NAME	SUMMARY OF BOOK, BUT DON'T GIVE AWAY THE ENDING!	TITLE OF BOOK	TITLE AUTHOR'S NAME	BRIEF DESCRIPTION OF MAIN CHARACTER
	SUMMARY OF AUTHOR'S LIFE	2-3 QUOTES THAT RECOMMEND OTHERS READ THE BOOK		CREATIVE ILLUSTRATION	ILLUSTRATION OF CHARACTER
	ILLUSTRATION OF AUTHOR	PUBLISHER'S NAME BARCODE 		YOUR NAME	

Make sure to include all necessary components to receive full points!

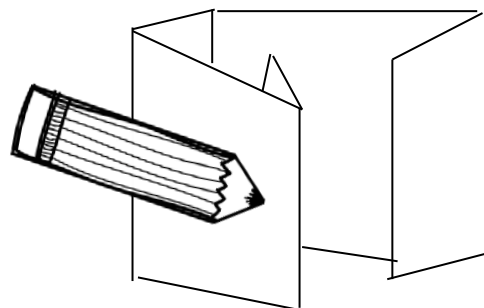

Cut and discard top portion of page.
Fold book jacket on dotted gray lines.

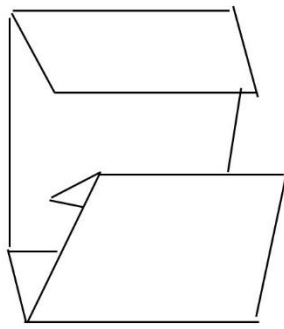

A large rectangular area with a solid black border. It contains four horizontal dotted lines, which serve as guides for folding the book jacket. The top portion of the page is cut off, as indicated by the instructions.

Name: _____

Book Jacket Grading Rubric

Front Cover: _____ / 15

- _____ Title (3)
- _____ Author's Name (3)
- _____ Your Name (3)
- _____ Illustration (6)

Rear Flap: _____ / 10

- _____ Author's Name (2)
- _____ Summary of Author's Life (6)
- _____ Illustration (2)

Back Cover: _____ / 20

- _____ Barcode & Publisher (5)
- _____ Book Summary (10)
- _____ Quotes (5)

Spelling/Grammar: _____ / 15

- _____ Correct Spelling & Grammar (15)

Front Flap: _____ / 20

- _____ Character Description (15)
- _____ Illustration (5)

Overall Creativity & Neatness: _____ / 20

- _____ Colorful & Creative (10)
- _____ Neatly Assembled (10)

TOTAL POINTS: _____ / 100

Name: _____

Book Jacket Grading Rubric

Front Cover: _____ / 15

- _____ Title (3)
- _____ Author's Name (3)
- _____ Your Name (3)
- _____ Illustration (6)

Rear Flap: _____ / 10

- _____ Author's Name (2)
- _____ Summary of Author's Life (6)
- _____ Illustration (2)

Back Cover: _____ / 20

- _____ Barcode & Publisher (5)
- _____ Book Summary (10)
- _____ Quotes (5)

Spelling/Grammar: _____ / 15

- _____ Correct Spelling & Grammar (15)

Front Flap: _____ / 20

- _____ Character Description (15)
- _____ Illustration (5)

Overall Creativity & Neatness: _____ / 20

- _____ Colorful & Creative (10)
- _____ Neatly Assembled (10)

TOTAL POINTS: _____ / 100

Book Jacket Example

Front Cover

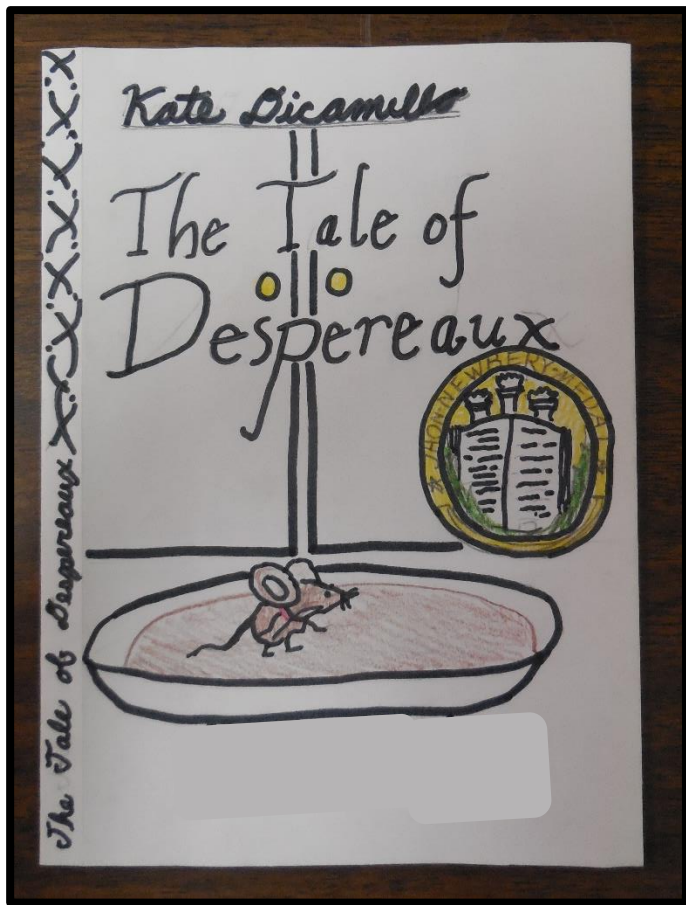

Back Cover

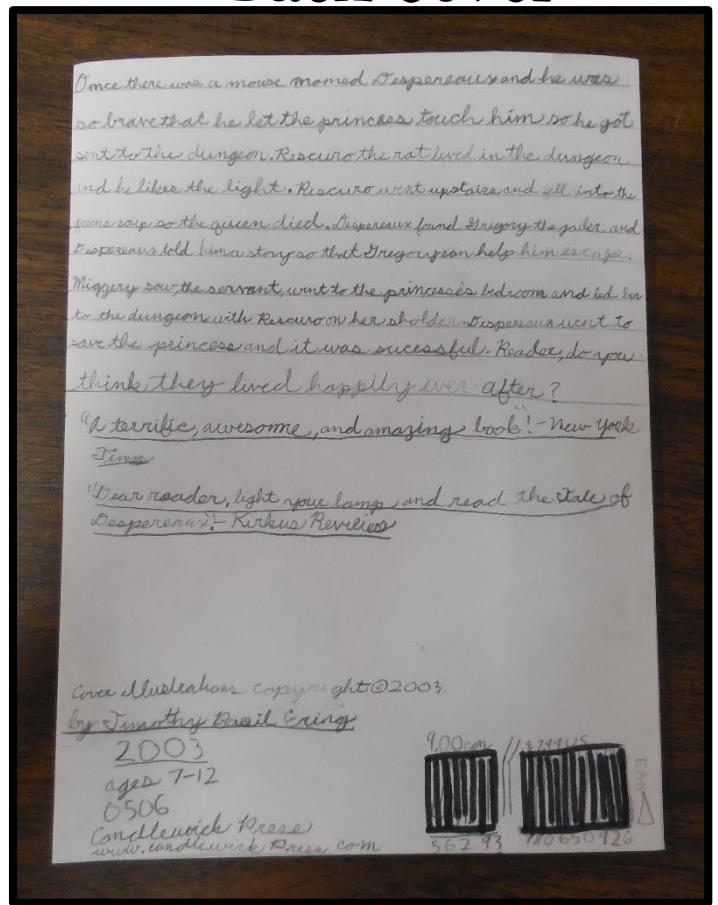

Inside Flaps

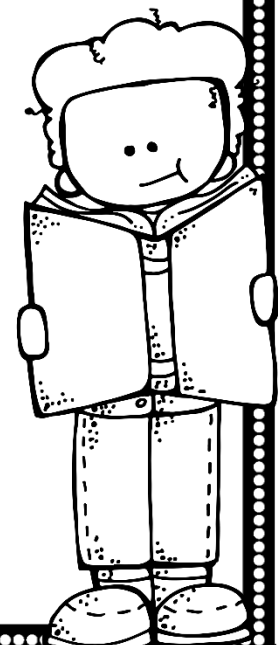
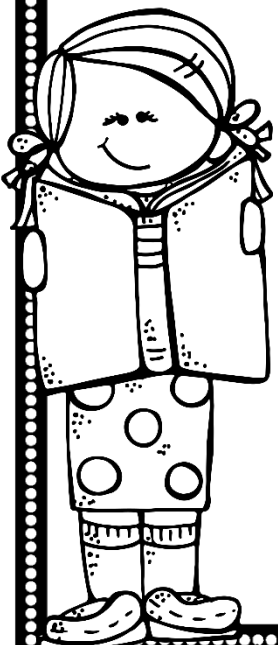
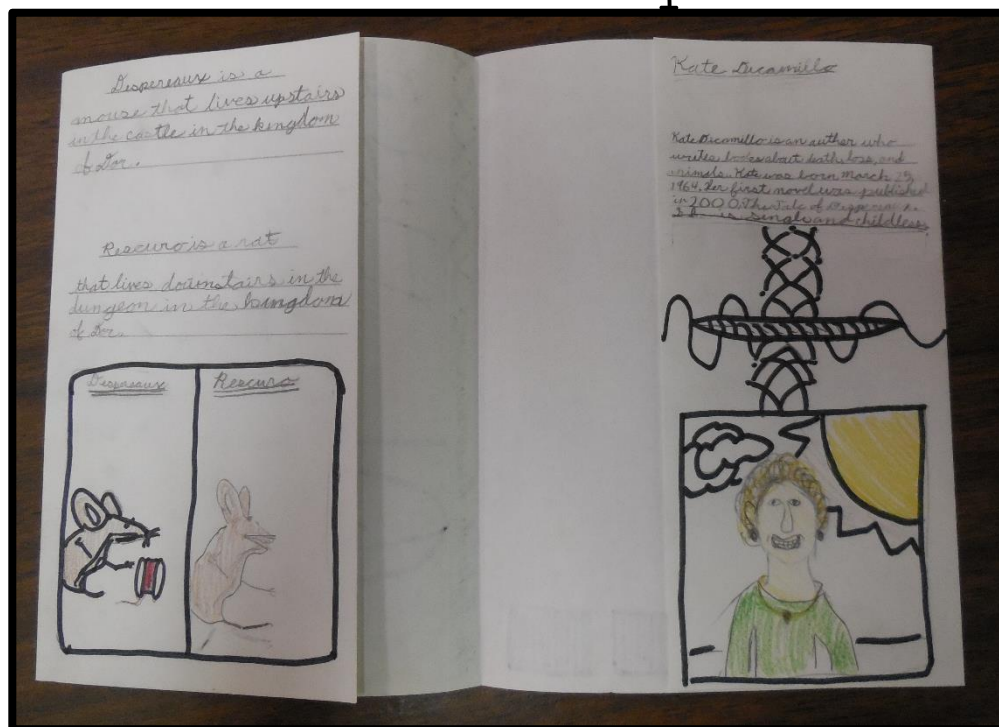

Book Jacket Example

Name: _____ Due Date: _____

Create a Book Jacket!

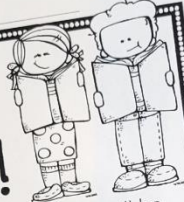

It's your job to create a book jacket! This project will be creative and fun! The purpose of a book jacket is to entice the reader by showing them highlights of the book in words and pictures. Be careful not to give away the entire plot!

REAR FLAP	BACK COVER	SPINE	FRONT COVER	FRONT FLAP
AUTHOR'S NAME SUMMARY OF AUTHOR'S LIFE ILLUSTRATION OF AUTHOR	SUMMARY OF BOOK, BUT DON'T GIVE AWAY THE ENDING! 2-3 QUOTES THAT RECOMMEND OTHERS READ THE BOOK PUBLISHER'S NAME BARCODE	TITLE OF BOOK	TITLE AUTHOR'S NAME CREATIVE ILLUSTRATION YOUR NAME	BRIEF DESCRIPTION OF MAIN CHARACTER ILLUSTRATION OF CHARACTER

Designing Your Book Jacket

Make sure to include all necessary components to receive full points!

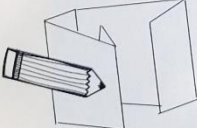

Name: _____

Book Jacket Grading Rubric

Front Cover: _____ / 15
 Title (3)
 Author's Name (3)
 Your Name (3)
 Illustration (6)

Rear Flap: _____ / 10
 Author's Name (2)
 Summary of Author's Life (6)
 Illustration (2)

Back Cover: _____ / 20
 Barcode & Publisher (5)
 Book Summary (10)
 Quotes (5)

Spelling/Grammar: _____ / 15
 Correct Spelling & Grammar (15)

Front Flap: _____ / 20
 Character Description (15)
 Illustration (5)

Overall Creativity & Neatness: _____ / 20
 Colorful & Creative (10)
 Neatly Assembled (10)

TOTAL POINTS: _____



The Tale of Despereaux
 By: Kate DiCamillo

